

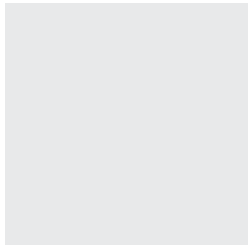



LISO
ø1200 h550







Q-TEK
Solid Surface



5
YEARS
GUARANTEE



Revêtement présentant une
excellente résistance à
l'hydrolyse.



Très résistant aux UV.



Revêtement de
DURETE SUPERIEURE
(<0,01 mm selon UNE EN 14688);
maximum autorisé 0,1 mm).



Traitement antibactérien
R<2 ISO 22196.



Installation:
Consulter le manuel
d'installation.

Les caractéristiques techniques peuvent être modifiées sans préavis. Tolérances dimensionnelles +/-5mm.

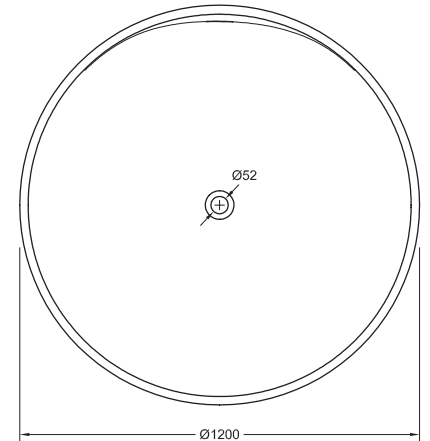
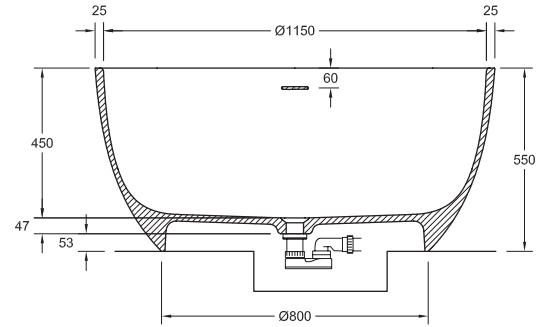
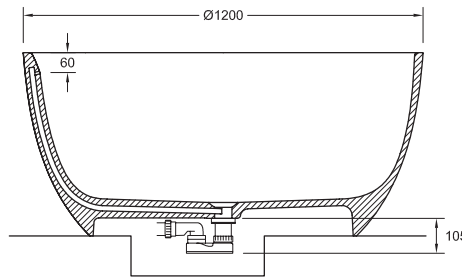

TEXTURE	Kg	L	mm
LISO	86	330	ø1200 h550

OPTIONS DE COULEUR



SUPER WHITE



BICOLORE



MONOCOLORE

COULEURS STANDARDS



ACCESSOIRES

BONDE CLIC-CLAC AVEC CLAPET INTÉGRÉ
EN TEXTURE ET COULEUR



TROP-PLEIN INTÉGRÉ INCLUS